

Wet Scrubber Application Guide

Impingement Plate Scrubbers

Venturi Scrubbers

Eductor Venturi Scrubbers

Three Types of Wet Scrubbers To Remove Vapors, Gases and Particulate

Impinjet® Impingement Plate Scrubbers

The Sly Impinjet scrubber collects particulates, and absorbs vapors, and gases. High collection efficiencies, (99+%), can be achieved with low water consumption and minimum pressure drop.

Venturi Scrubbers for Fine Particulates

The Sly Venturi scrubber offers more advantages in separating and recovering ultra-fine particulates and liquid mists than other gas cleaning methods.

Eductor Venturi Scrubbers

Eductor scrubbers are designed to remove soluble gases and particulate by inducing a gas flow using high pressure liquid focused into a venturi throat.



Eductor Venturi Scrubber



Venturi Scrubber



Impinjet® Scrubber

Basic Criteria for Sizing A Wet Scrubber

The first step is to determine which type of Sly scrubber to select. The nature of the pollutant or contaminant will determine if the Venturi, Impinjet, or combination scrubber system is best suited for your application.

Sizing the scrubber is the next step. The factors affecting sizing are gas flow rate, temperature, pressure, gas composition, humidity, contaminant loading and desired outlet conditions. Also, the availability of an appropriate scrubbing liquid is an important consideration.

Gas streams entering a wet scrubber may or may not be fully saturated, however they will exit the scrubber fully saturated. This process of saturation results in a change in volume, temperature and density.

The overall scrubber size (diameter) is a function of velocity of saturated gas through the scrubber shell. By knowing the moisture content of a gas stream (generally expressed as pounds of water per pound of dry gas) and the inlet temperature; the saturation temperature and saturated volume content can be calculated. The volume correction chart at the right can be used for a close approximation of the change in gas volume.

Example:
10,000 ACFM @ 450°F containing 0.15# H₂O/# dry air

The chart shows a correction factor of 0.75. Inlet volume x correction factor = outlet volume or 10,000 x 0.75 = 7500 ACFM. The scrubber would be sized for this saturated outlet volume.

For Impinjet scrubbers, the maximum capacity is based on shell velocity of 500 feet per minute. Dividing the corrected or saturated volume by 500 yields the overall tower cross-sectional area from which the diameter can be determined.

Example (continued):
7500 ft³/min = 15 ft²
500 ft/min
Area = 15 ft² = $\frac{\pi D^2}{4}$

D=diameter
Diameter = 4.37 ft

The calculated diameter becomes the reference point for equipment selection. (Refer to specific product bulletin.)

The approximate particulate and/or mist efficiencies for Venturis and Impinjet scrubbers can be determined by the efficiency chart on the right.

To determine the number of Impinjet stages required for the absorption of gases such as acids, requires a complex calculation with too many variables to use a simple chart. However, for either particulate or

absorption the following information is important:

- gas volume
- process description
- temperature
- particle size
- moisture content
- type of contaminant

For assistance in understanding your problem, call your local representative or Sly at 1-800-334-2957.

VOLUME CORRECTION CHART

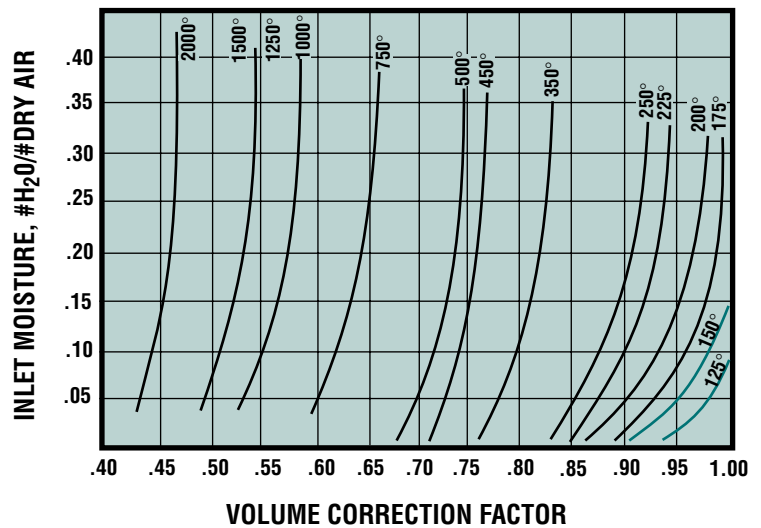

PARTICULATE COLLECTION EFFICIENCIES

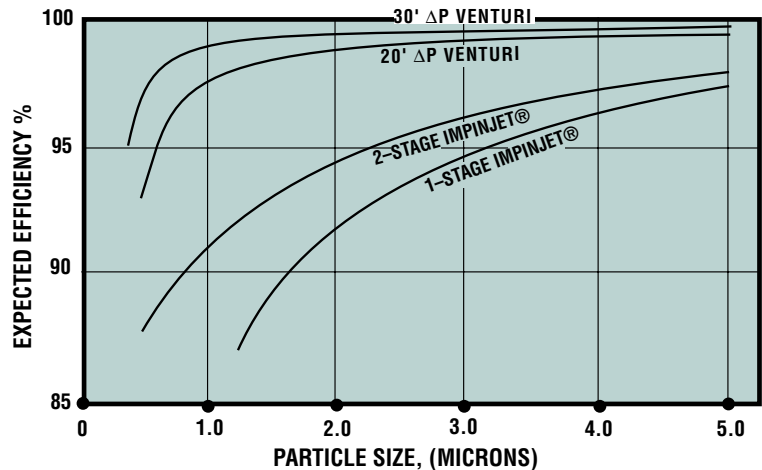

Impinjet® Scrubbers

Collect Particulates & Absorb Vapors and Gases

Rugged and uncomplicated in design, Impinjet Scrubbers can realize efficiencies in excess of 99% on many types of dust or gases. Capacities range from 500 to over 100,000 CFM. Depending upon application, water requirements vary from less than 1-1/2 GPM per 1,000 ACFM to a typical 3 GPM per 1,000 ACFM.

Unique flexibility is furnished by Impinjet Scrubbers. Made with the future in mind, additional stages can be added to existing installations to improve efficiency to handle tomorrow's requirements—*without increasing liquid consumption*. There is no need to buy complete new units.

Benefits

- 1.) High absorption efficiency for **gases and vapors**. Experts agree that plate towers have the ability to remove gaseous pollutants to any desired concentration if a sufficient number of plates are used. This means high mass transfer rates can be achieved.
- 2.) 98+% collection efficiency for **particles** 5 microns in size or larger.
- 3.) These high efficiencies are achieved at a low pressure drop.

- 4.) **Both** particle collection and absorption of gases, vapors, etc. can be done at the same time.
- 5.) Multiple stages can be provided.
- 6.) No moving parts to maintain.
- 7.) Extensive experience with many applications available.
- 8.) Needs less scrubbing fluid than most other scrubbers.
- 9.) Can handle high temperatures and temperature fluctuations.

Cooling and Condensing

The outlet gas can be cooled to less than 5°F above the temperature of the incoming liquid. Often solvents such as alcohols, pentane, hexane, acetone, ethylene glycol, chloroform, etc. are recovered from inert gas streams such as nitrogen or carbon dioxide. Chilled solvent is used as direct contact condensing liquid and removes the heat from the gas stream as it gains heat.

Scrubbers also recover waste heat. Heat from dryers and other processes that would normally be exhausted can be used to heat water being fed to the scrubber almost to the wet bulb temperature of the inlet gas. For cooling and

condensing and for heat recovery, our designs can accommodate high hydraulic loadings.

Operating Principles

The gas passes up through the openings in the perforated plates (trays) which hold a bed of liquid. The secret is in the scrubber's design which uses an impingement baffle above each individual hole.

The tiny droplets, created by the wetted baffles, are the heart of the collection process.

Gas velocities of 60 to 75 feet/second through the holes result in thousands of jets which atomize the liquid into droplets on the order of 100 microns in diameter to clean the contaminated gas. This entraps the particles in the scrubbing liquid. Each jet aspirates liquid from the blanket of scrubbing fluid and results in a wetted target surface on the baffle which is located just above the point of maximum velocity (vena contracta).

In operation, the scrubber is highly pluggage-resistant. The continuous violent agitation of the blanket of scrubbing fluid prevents settling of particles and flushes them away.

Intimate gas/liquid contact results in the maximum collection efficiency for particles and droplets as well as absorption (mass transfer) of gases and vapors. When used for absorption, low outlet emissions can be achieved by virtue of the scrubber's countercurrent operation. The Sly Impinjet Gas Scrubber is able to reduce gaseous pollutants to any desired concentration if a sufficient number of plate stages is used.

See data sheet for technical details.

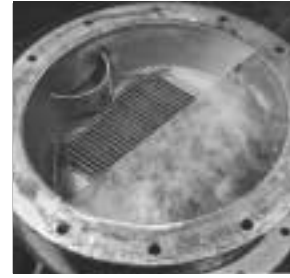
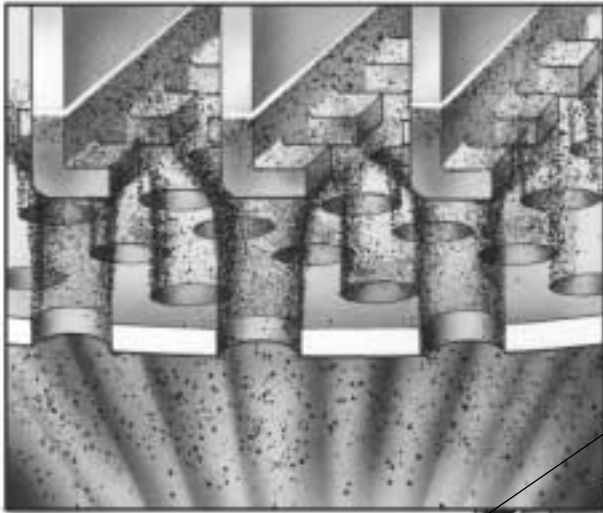

Venturi Effect results in turbulent interaction of liquid and particulate-laden gas flowing through perforated plate and striking the wetted impingement baffle grid. (Each hole has an individual impingement surface.) Minute liquid droplets are formed which entrap suspended matter in gas. Particulate carrying droplets mix with water flowing across baffles for ultimate disposal through the drain. Cleaned gas passes through the mist eliminator for return to process or atmosphere.

- 1.) Scrubber Outlet
- 2.) Fixed Blade Mist Eliminator - assures droplet-free air to process or atmosphere.
- 3.) Impingement Baffle Plates - create interaction of gas stream and liquid. Additional plates (trays, stages) provide increased efficiency.
- 4.) Plate Discharge and Seal Drain - directs slurry to bottom of scrubber for removal. Non-clogging seal prevents short circuiting of gas.

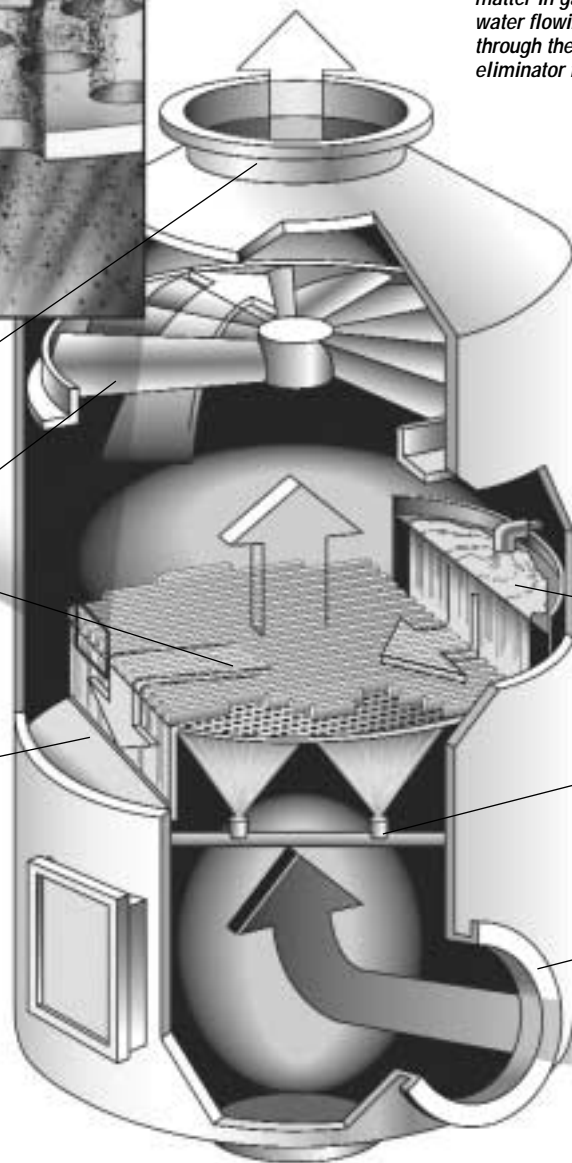

- 5.) Liquid Supply and Weir (dam) - adjustable weir provides uniform liquid flow to plates.
- 6.) Spray Section - for cooling and entrapment of larger particles. Spray washes under side of plate and walls to prevent material build-up. Sprays are non-clogging.
- 7.) Gas Inlet

Venturi Scrubbers

Collect Ultrafine Particles and Mists

The Venturi Scrubber uses the differential between high velocity gases and free-flowing water to create droplets which entrap contaminants, hold them in suspension and deliver them as a highly concentrated slurry. The Sly Venturi Scrubber offers more advantages in separating and recovering liquid mists and ultra-fine particulate than other gas cleaning methods.

Simple in design, yet highly efficient, this Sly Venturi Scrubber incorporates features calculated to maximize collection efficiency while minimizing operating and maintenance costs. They range from a non-plugging, trouble-free method of introducing scrubbing liquid and a simple, easily-adjusted throat for optimizing efficiency, to a flooded elbow arrangement that collects agglomerated particulate while providing an abrasion-resistant barrier to deter scrubber wear. Extremely important in these days of rising

energy costs is an adjustable pressure drop provision and energy regain feature which combine to reduce power consumption and operating costs.

The Sly Venturi Scrubber serves industry in several ways. It removes pollutants present in process gas streams. This includes removing hazardous and nuisance dusts, fumes and mists from stack gases. Cleaning process gas streams to remove oils, dusts and other particulate, this scrubber offers industry an opportunity to recycle these gases as fuels or process raw materials. Finally, the Sly Venturi Scrubber makes it possible to reclaim valuable materials which can result in significant process savings.

Sly Inc., with over 125 years of service to industry, offers complete air pollution control services. We begin with an application survey, engineering recommendations, fabrication, and end with factory assembly of a scrubbing system to provide a satisfactory solution to your gas scrubbing problem.

Benefits

This Sly scrubbing system brings together virtually all the features you should insist upon for your application:

- 1.) Simple, easily adjustable throat permits setting pressure for maximum efficiency. Can be fine-tuned to application while scrubber is running. Throat damper blades are readily replaceable.
- 2.) Variable-spin damper in separator maintains proper velocity for collection of fine droplets.
- 3.) Flooded elbow provides a wetted surface for collection of large agglomerated liquid droplets. Also serves as a barrier to eliminate equipment wear. Drains directly into separator sump.
- 4.) Removable scrubbing liquid piping - no nozzles to wear or plug.
- 5.) Access door permits inspection of flooded elbow and spin damper.
- 6.) Simple open design has low potential for build-up and pluggage.
- 7.) Temperature and corrosion resistant construction is available.
- 8.) Can employ a high concentration slurry as scrubbing liquid.

Operating Principles

The incoming gas is accelerated to a high velocity at the scrubber's throat where it comes into contact with the scrubbing liquid. The liquid is atomized into fine droplets which entrap the particulate with high collection efficiency.

Downstream from the throat, the cleaned gas decelerates and the particulate-laden droplets collide and agglomerate. The large, heavy, agglomerated droplets are driven into the flooded elbow for easy disposal. Droplets too small for collection at the flooded elbow are collected in the separator to complete the cleaning operation.

Pressure drop across the venturi throat is a measure of the energy needed to atomize the scrubbing liquid and to perform the cleaning operation. The higher the pressure drop, the higher the collection efficiency.

The Sly Venturi offers the most efficient design for putting pressure drop to work. Its adjustable throat feature optimizes scrubbing efficiency by maintaining just the right pressure drop. This, combined with the unit's energy regain section, significantly reduces power consumption and operating costs.

See data sheet for technical details.

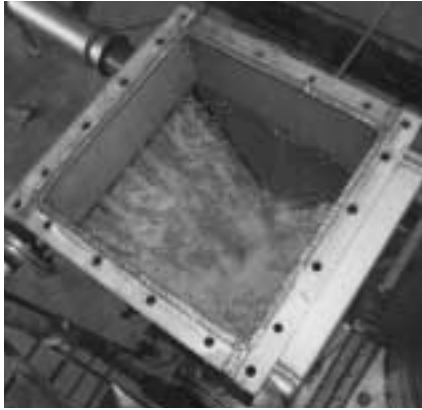

Flooded inlet eliminates wet/dry interface build-up problems.



Often a hot gas stream has a valuable particulate to be recovered. Silver is recovered from film incineration using this Venturi scrubber.

Adjustable Throat

Simple, easily-adjusted throat optimizes efficiency. Operates manually-automatic control is offered as an optional extra.

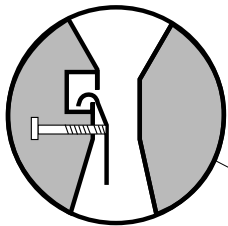

Throat adjustment.

Water atomization and particle impaction.

Energy regain section reduces power consumption.

Clean out door.

Flooded elbow collects agglomerated, particle carrying droplets and functions as an abrasion deterrent.

Access door permits inspection of flooded elbow, shielded inlet and variable spin damper.

Damper in fully open position.

Damper partially closed to increase spin velocity.

Removable piping distributes water without using nozzles.

Wetted surfaces eliminate wet/dry interface build-up.

High relative velocity maximizes capture of gas stream pollutants.

Separator collects ultrafine droplets too small for impingement collection in flooded elbow.

Tangential outlet minimizes pressure drop.

Shielded water inlet prevents re-entrainment of liquid in gas stream.

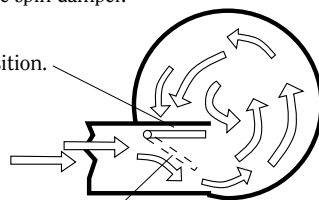

Variable Spin Damper is manually adjusted to control spin velocity. Proper adjustment maintains the spin velocity necessary to efficiently collect entrained liquid droplets.

Eductor Venturi Scrubbers

Eductor scrubbers are designed to remove soluble gases and particulate by inducing a gas flow using high pressure liquid focused into a venturi throat.

Additionally, eductor scrubbers can be used for direct-contact condensation. A high liquid flow rate makes the Sily eductor particularly appropriate for collection of sticky and/or gummy particulate, as well as gases which decompose upon contact with water, such as SiCl_4 and H_2SiF_6 .

Eductors are easily staged with other collection devices such as impingement plate scrubbers, packed towers or additional eductor scrubbers.

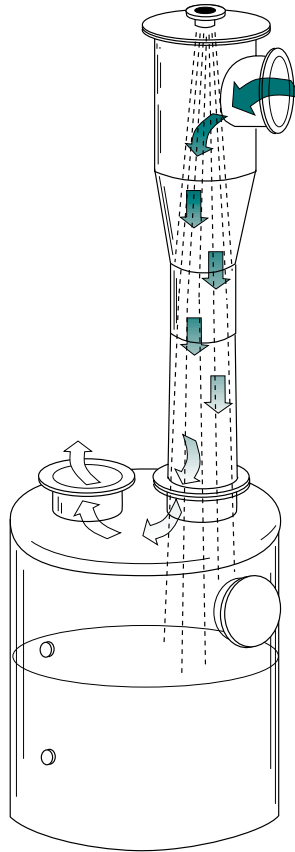

Sly Scrubbers at Work



Gas Scrubber Removes Hazardous Vapors — An Impinjet® gas scrubber has been employed by a major producer of industrial chemicals to remove hazardous (noxious) vapors. The scrubber vents both bottle filling and dry bulk filling areas at the company, which produces hydrochloric, sulfuric and nitric acid as well as formaldehyde and ammonia.

The system handles 2,500 CFM. Efficiencies exceeding 95% are reported. The high efficiency of the scrubbing system is due to the unique design of the impingement baffle plates, which cause the contaminated air to mix intimately with the scrubbing solution.



Scrubber Cleans and Absorbs Acid Gases and Particulate From Medical Waste Incinerator — An Impinjet® wet gas scrubber is used by this company to clean exhaust gases from its medical waste incinerator.

7258 CFM of gas at 1800°F from a 100 lb. per hour incinerator is handled by this skid-mounted wet gas scrubber. A proven impingement design creates turbulent conditions to insure intimate contact between particulates and acid gases for thorough removal of pollutants, including HCL.



Eductor Venturi/Packed Tower Combination Removes Particulate and Absorbs Alcohol Vapors — A combined eductor/packed tower collector that removes solid particulate and absorbs alcohol has been successfully employed by this major specialty chemical producer.

The equipment vents a variety of process equipment. The eductor venturi induces the gas flow using a high pressure and volume of recirculated water focused into the throat of the venturi. Particulate matter is removed in the venturi.

After the eductor, a packed tower scrubber with an extended packed section removes alcohol vapors by counter-current contact with a once through flow of fresh water. The equipment is stainless steel construction, designed for 500 CFM.



Scrubber Collects SO₂ And Particulate At Reprocessor of Petroleum Catalysts — An Impinjet® gas scrubber is used by this recycler of spent petroleum and chemical refining catalysts to clean flue gas from its ovens.

Carbon and sulfur from used catalysts is thermally oxidized by the company, creating sulfur dioxide and particulates, primarily carbon. Previously, a packed tower style scrubber was used to clean the resulting flue gas. Unfortunately, the packed tower tended to channel, as well as not collect particulate. The Sly scrubber uses a proven impingement design, which creates turbulent conditions to insure intimate contact between the gas contaminants and the scrubbing solution. This results in efficient removal of both particulate and SO₂.

Sly's Approach to Air Pollution Control:

- conservative design
- flexible engineering
- controlled manufacturing
- comprehensive field services

Many companies make air pollution control equipment, but none have been doing it as long as Sly.

More than a century has passed since our original patent for cloth dust filters. Over the years, we've learned plenty about the application and fabrication of dust collectors and scrubbers. Here are the main points:

"In the pollution control business, conservative application of technology is best."

Equipment misapplication has no place in the pollution control business. Not only is improper equipment apt to fall short of collection requirements, it is oftentimes more expensive to operate than the proper machinery. For example, incorrect sizing and improper media choice can easily lead to excessive maintenance and costly downtime. When you deal with Sly, we have your best long term interests in mind.

"We believe in fitting the equipment to the customer's needs, not the customer to the equipment's capabilities."

Unlike many equipment suppliers, we refuse to mass-produce product and then hope for a good fit. We have maintained flexibility in our engineering techniques which permits us to manufacture each order to fit the task at hand, while maintaining a price to you that is comparable to mass-produced equipment.

In many cases it costs no more to get the very best equipment for the job.

This approach earns us the respect and repeat business of many sophisticated buyers of pollution control equipment. These people, many of whom buy dozens of collectors or scrubbers every few years, have always represented a large portion of our customer base.

"We build our own equipment...for some very good reasons."

Part of the reason Sly can custom-make a collector for you while keeping a competitive price is just that: we **are** the manufacturer. Unlike the majority of our competitors, we don't job out our production. We do our own engineering, sewing, metal fabrication, painting, assembly, quality control, and laboratory R&D. This way we control every step of the process, allowing us great flexibility to build the best collector or scrubber for your individual needs. We have a strong commitment to shipping dates and routinely guarantee ship dates when requested.

"Our obligation to the customer doesn't end when the equipment is shipped."

Sly's staff engineers can promptly assist you in troubleshooting or with other field service

problems should they arise at your facility. This commitment to total customer support helps guarantee superior value for your investment.

"We're a private company, and intend to stay that way."

The corporate restructurings and short term goals of today's business scene aren't for us. Sly is owned and operated by descendants of the founding family. We are in the business for the long run, and will maintain the professionalism and continuity required to contribute to the long term success of your business.



P.O. Box 5939, Cleveland, Ohio 44101
(440) 891-3200 • Fax (440) 891-3210
1-800-334-2957 • Web: <http://www.slyinc.com>
E-mail: info@slyinc.com

Eductor Venturi Scrubbers

- Need to comply with air quality codes? Our Eductor scrubbers are designed to specifically meet your performance requirements.
- Got a tough application? Make use of our expertise... call us with your special requirements.
- Need a unique solution to your problem? We offer custom engineering design. We design your Eductor around your application.
- Can't wait for a custom solution? Because Sly does its own manufacturing, we can deliver a custom system engineered to meet your demanding process, and deliver it *on time!*



Eductor scrubbers are designed to remove soluble gases and particulate by inducing a gas flow using high pressure liquid focused into a venturi throat. Additionally, eductor scrubbers can be used for direct-contact condensation. A high liquid flow rate makes the Sly eductor particularly appropriate for collection of sticky and/or gummy particulate, as well as gases which decompose upon contact with water, such as SiCl_4 and H_2SiF_6 .

You get this...	...Because we do this!
• High Efficiency	√ State-of-the-art materials
• Long Life	√ Materials selected for optimum corrosion resistance √ Internals are generally inert to the process environment
• Minimum Maintenance	√ No moving parts √ Convenient access locations
• Low Overall Water Consumption	√ Recirculate Solution
• Flexibility	√ Each is custom-engineered √ Is easily staged with other collection devices such as impingement plate scrubbers, packed towers or additional eductor scrubbers

Eductor Gas Scrubbers

Specifications:

Materials:

Shell:

- Mild steel
- 304 SS
- 316 SS
- Special alloy
- FRP

Design Pressure:

- ± 6" wg (std.)
- Other

Standard Features:

- Access door in tank
- Flanged inlet and outlet
- Integral recirculation reservoir
- Anchor lugs
- Lifting lugs

Optional

Accessories/Features:

- Pressure differential gauge
- Internal sloped bottom
- Cone bottom
- Recirculation pump
- Recirculation piping
- Instrumentation package
- Exhaust fan
- Skid mounting (6' diameter & smaller)
- Control panel
- Sump heaters (freeze protection)
- Chemical feed systems

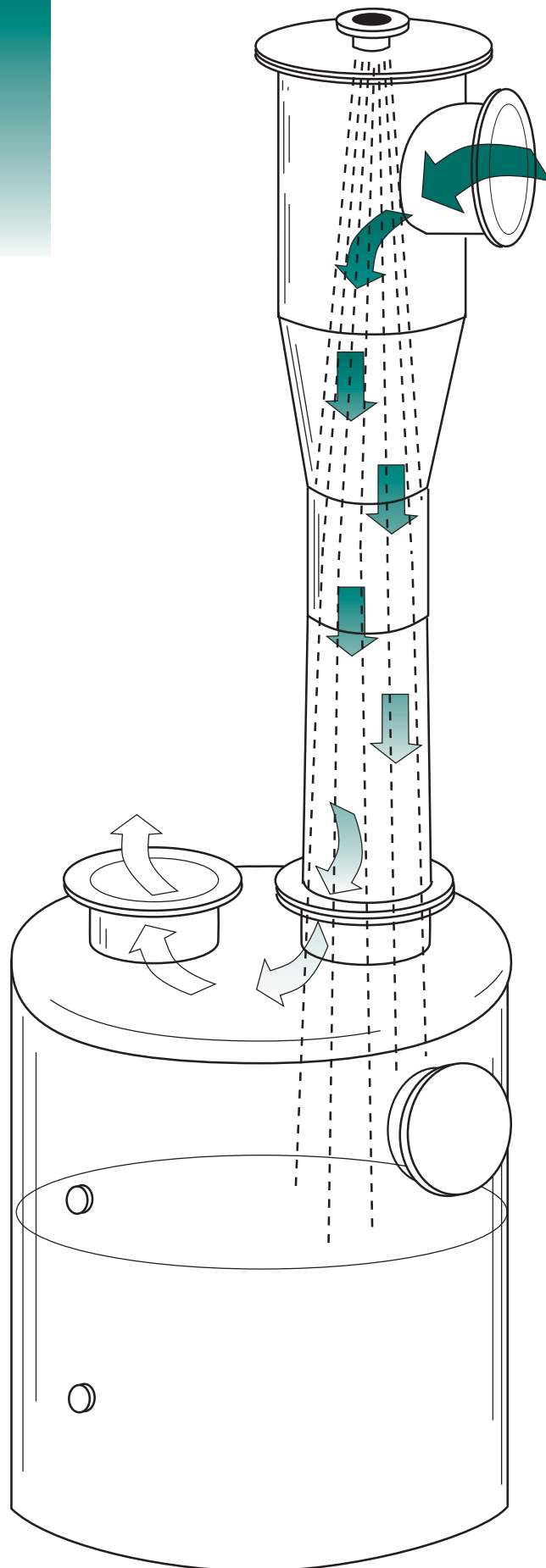

P.O. Box 5939
Cleveland, OH 44101
Telephone: (440) 891-3200
Fax: (440) 891-3210
(800) 334-2957
www.slyinc.com
E-mail: info@slyinc.com

Impinjet® Scrubbers

Collect Particulates and Absorb Odors, Vapors and Gases

Rugged and uncomplicated in design, Impinjet Scrubbers can realize efficiencies in excess of 99% on many types of dust or gases.

Both particle collection and absorption of gases, odors, vapors, etc. can be done at the same time.

Ready for Today...Ready for the Future

Unique flexibility is furnished by Impinjet Scrubbers. Made with the future in mind, additional stages can be added to existing installations to improve efficiency to handle tomorrow's requirements—without increasing liquid consumption. There is no need to buy complete new units.

For Cooling & Condensing, Too

The outlet gas can be cooled to less than 5°F above the temperature of the incoming liquid. Often solvents such as alcohols, pentane, hexane,

acetone, ethylene glycol, chloroform, etc. are recovered from inert gas streams such as nitrogen or carbon dioxide. Chilled solvent is used as direct contact condensing liquid and removes the heat from the gas stream as it gains heat.

Scrubbers also recover waste heat. Heat from dryers and other processes that would normally be exhausted can be used to heat water being fed to the scrubber almost to the wet bulb temperature of the inlet gas. For cooling and condensing and for heat recovery, our designs can accommodate high hydraulic loadings.

Highlights

- High absorption efficiency for gases, odors and vapors
- Efficiencies exceeding 98% for particles 5 microns or larger
- Multiple stages can be added to improve efficiency
- Capacities from 500 to over 100,000 CFM
Water requirements as low as 1-1/2 GPM per 1000 ACFM (typically, 3 GPM per 1000 ACFM)

Standard Impinjet Efficiency@ Pressure Drop of 1-1/2" per Stage

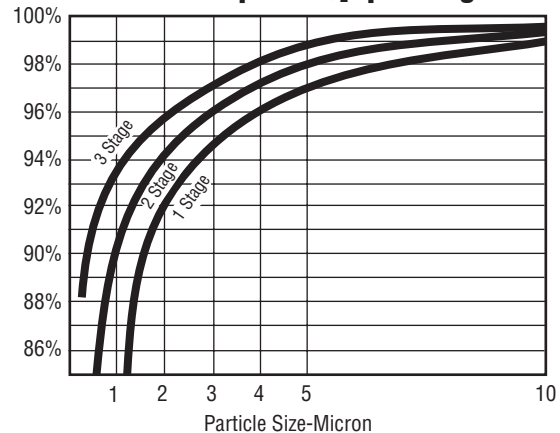

Pressure Drop @ 70°F.

Number on Stages	Normal Capacity (Inches, W.G.)	Max. Capacity (Inches, W.G.)
One Stage	3.0	4.25
Two Stage	4.5	6.4
Three Stage	6.0	8.5

Pressure drop is an important consideration in evaluating the efficiency expected of a scrubber in a given application and in fan, drive and motor selection.

When high efficiency is required, the use of additional stages provides a corresponding increase in pressure drop.

The above chart shows standard pressure drop in inches, w.g., across scrubber for 1 stage, 2 stages and 3 stages.

To correct pressure drop to operating conditions, multiply standard pressure drop by the ratio of outlet density to standard density.

Example: Using .0615 #/Cu. Ft. Dry Air from Density Correction example and the 1 stage average capacity pressure drop of 3" at 70°F. (density .075) the operating pressure drop is: 3" \times .0615/.075 = 2.46 inches, w.g.

Impinjet® Scrubbers

Standard Equipment

- Stainless steel impingement baffles
- Fixed blade mist eliminator
- Conditioning spray
- Carbon steel/Stainless steel construction
- Access doors (bolted)
- Full draining design

Optional Equipment and Features

- FRP and plastic construction
- Mesh and chevron mist eliminators
- Quick opening access doors
- Integral sumps
- Complete package systems

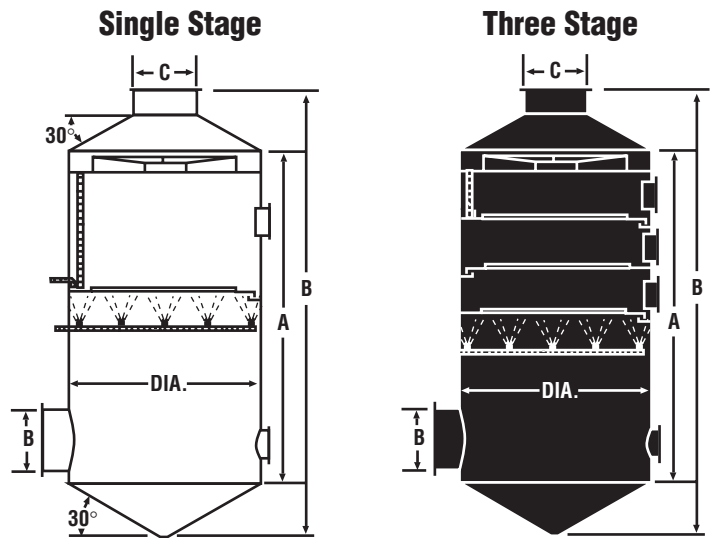

Outlet Volume (CFM)

Normal Capy 420 FPM	Max. Capy 500 FPM	Dia
740	885	1'-6"
1350	1550	2'-0"
2100	2450	2'-6"
3000	3500	3'-0"
4050	4800	3'-6"
5300	6250	4'-0"
6700	7950	4'-6"
8250	9800	5'-0"
10000	11850	5'-6"
11900	14100	6'-0"
13950	16550	6'-6"
16200	19200	7'-0"
18600	22050	7'-6"
21150	25100	8'-0"
23850	28350	8'-6"
26750	31800	9'-0"
29800	35400	9'-6"
33000	39250	10'-0"
36400	43250	10'-6"
39950	47500	11'-0"
43650	51900	11'-6"
47550	56500	12'-0"
51550	61350	12'-6"
55750	66500	13'-0"
60150	71550	13'-6"
64700	76950	14'-0"

Nozzle Sizes

Plate Water Inlet I.P.S. Inches	Spray Water Inlet I.P.S. Inches	Bottom Drain I.P.S. Inches	Inlet Flange Dia. B	Outlet Flange Dia. C
1/2	1/2	1	6"	7"
3/4	1/2	1	8"	8"
1	3/4	1 1/4	10"	11"
1	1 1/4	1 1/4	1'-0"	1'-1"
1 1/4	1	1 1/2	1'-2"	1'-3"
1 1/4	1	1 1/2	1'-4"	1'-5"
1 1/4	1	1 1/2	1'-6"	1'-7"
1 1/2	1 1/4	2	1'-7"	1'-9"
1 1/2	1 1/4	2	1'-9"	1'-11"
1 1/2	1 1/4	2	2'-0"	2'-2"
2	1 1/4	2 1/2	2'-2"	2'-4"
2	1 1/2	2 1/2	2'-4"	2'-6"
2	1 1/2	2 1/2	2'-6"	2'-8"
2	1 1/2	2 1/2	2'-8"	2'-10"
2 1/2	2	3	2'-10"	3'-0"
2 1/2	2	3	3'-0"	3'-2"
2 1/2	2	3	3'-2"	3'-4"
2 1/2	2	3	3'-0"x3'-2"	3'-7"
2 1/2	2	3	3'-0"x3'-6"	3'-9"
3	2	4	3'-0"x3'-10"	3'-11"
3	2	4	3'-0"x4'-2"	4'-1"
3	2 1/2	4	3'-0"x4'-6"	4'-4"
3	2 1/2	4	3'-0"x5'-0"	4'-6"
3	2 1/2	4	3'-0"x5'-4"	4'-8"
3	2 1/2	4	3'-0"x5'-10"	4'-10"
4	2 1/2	4	3'-0"x6'-4"	5'-0"

Single Stage Dimensions

Two Stage Dimensions

Three Stage Dimensions

Impinjet Number	Straight Side A	Overall Height B	Impinjet Number	Straight Side A	Overall Height B	Impinjet Number	Straight Side A	Overall Height B
115	5'-4"	6'-4"	215	7'-4"	8'-4"	315	9'-4"	10'-4"
120	5'-6"	6'-9"	220	7'-6"	8'-9"	320	9'-6"	10'-9"
125	5'-9"	7'-2"	225	7'-9"	9'-2"	325	9'-9"	11'-2"
130	6'-0"	7'-8"	230	8'-0"	9'-8"	330	10'-0"	11'-8"
135	6'-3"	8'-2"	235	8'-3"	10'-2"	335	10'-3"	12'-2"
140	6'-6"	8'-7"	240	8'-6"	10'-7"	340	10'-6"	12'-7"
145	6'-9"	9'-1"	245	8'-9"	11'-1"	345	10'-9"	13'-1"
150	7'-3"	9'-10"	250	9'-3"	11'-10"	350	11'-3"	13'-10"
155	7'-6"	10'-3"	255	9'-6"	12'-3"	355	11'-6"	14'-3"
160	7'-9"	10'-9"	260	9'-9"	12'-9"	360	11'-9"	14'-9"
165	8'-0"	11'-3"	265	10'-0"	13'-3"	365	12'-0"	15'-3"
170	8'-3"	11'-10"	270	10'-3"	13'-10"	370	12'-3"	15'-10"
175	8'-6"	12'-3"	275	10'-6"	14'-3"	375	12'-6"	16'-3"
180	9'-3"	13'-3"	280	11'-3"	15'-3"	380	13'-3"	17'-3"
185	9'-9"	13'-11"	285	11'-9"	15'-11"	385	13'-9"	17'-11"
190	10'-0"	14'-5"	290	12'-0"	16'-5"	390	14'-0"	18'-5"
195	10'-6"	15'-2"	295	12'-6"	17'-2"	395	14'-6"	19'-2"
1100	10'-9"	15'-8"	2100	12'-9"	17'-8"	3100	14'-9"	19'-8"
1105	11'-0"	16'-1"	2105	13'-0"	18'-1"	3105	15'-0"	20'-1"
1110	11'-6"	16'-10"	2110	13'-6"	18'-10"	3110	15'-6"	20'-10"
1115	13'-0"	18'-7"	2115	15'-0"	20'-7"	3115	17'-0"	22'-7"
1120	13'-3"	19'-1"	2120	15'-3"	21'-1"	3120	17'-3"	23'-1"
1125	13'-6"	19'-7"	2125	15'-6"	21'-7"	3125	17'-6"	23'-7"
1130	13'-9"	20'-1"	2130	15'-9"	22'-1"	3130	17'-9"	24'-1"
1135	14'-0"	20'-6"	2135	16'-0"	22'-6"	3135	18'-0"	24'-6"
1140	14'-3"	21'-0"	2140	16'-3"	23'-0"	3140	18'-3"	25'-0"



TECHNOLOGY FOR A CLEAN ENVIRONMENT

P.O. Box 5939
 Cleveland, OH 44101
 Telephone: (440) 891-3200
 Fax: (440) 891-3210
 (800) 334-2957
 www.slyinc.com
 E-mail: info@slyinc.com

Venturi Scrubbers

Collect Ultrafine Particles and Mists

The Venturi Scrubber uses the differential between high velocity gases and free-flowing water to create droplets which entrap contaminants, hold them in suspension and deliver them as a highly concentrated slurry.

Unsurpassed for Separating and Recovering Liquid Mists and Ultrafine Particulate

Simple in design, yet highly efficient, the Sly Venturi Scrubber incorporates features calculated to maximize collection efficiency while minimizing operating and maintenance costs. They range from a non-plugging, trouble-free method of introducing scrubbing liquid and a simple, easily-adjusted throat for optimizing efficiency, to a flooded elbow arrangement that collects agglomerated particulate while providing an abrasion-resistant barrier to deter scrubber wear.

Cleans and Reclaims

The Sly Venturi Scrubber serves industry in several ways. It removes pollutants present in process gas streams. This includes removing hazardous and nuisance dusts, fumes and mists from stack gases. Cleaning process gas streams to remove oils, dusts and other particulate, this scrubber offers an opportunity to recycle these gases as fuels or process raw materials.

Venturi Scrubber Highlights

- Collects fine particles & mists
- Adjustable throat permits fine-tuning to maximize efficiency
- High efficiencies for sub-micron particulate
- Water requirements are typically 7.5 GPM per 1000 CFM
- Capacities from 1000 to 100,000 CFM

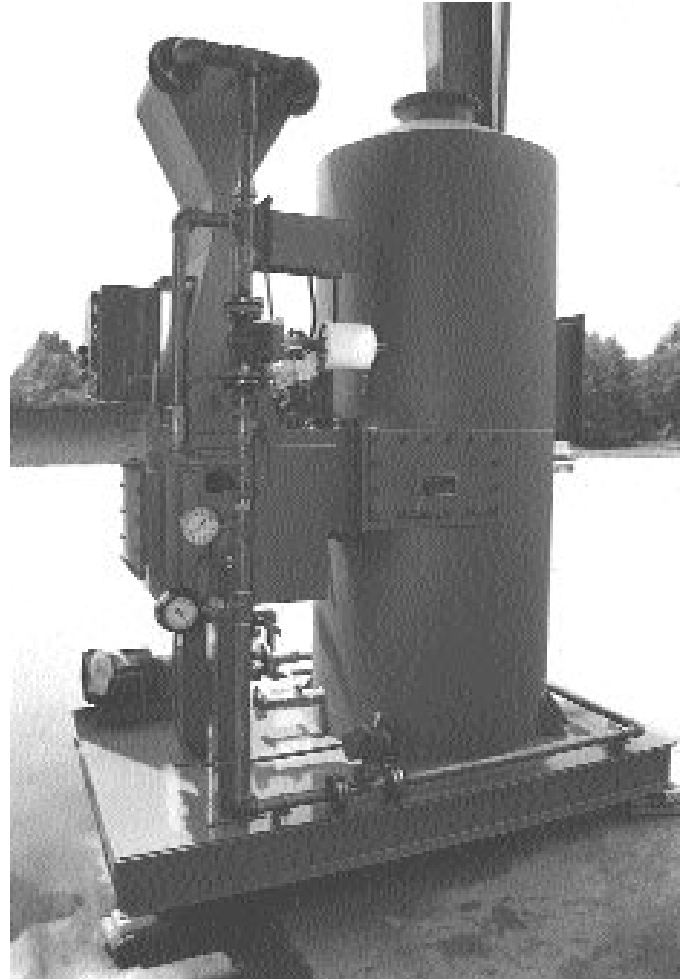

Venturi Scrubbers

Standard Equipment

- Manually adjustable throat
- Adjustable cyclonic spin damper
- Flooded elbow
- Wetted approach inlet
- Removable liquid distributors
- Access doors (bolted)
- Carbon steel/Stainless steel construction

Optional Equipment and Features

- Auto adjustable throat
- Corrosion resistant alloy construction
- Quick opening doors
- Complete package systems

Venturi Scrubber Capacities & Dimensions

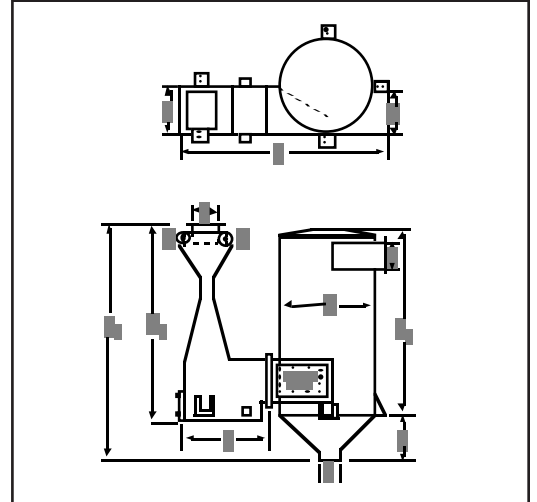

Size	Nominal Capacity Sat. CFM	Inlet & Outlet A	Sep. Dia. B	Sep. C ₁	Vent C ₂	Overall Height C ₃	Overall Width D	Venturi Width E	Sep. Cone F	Drain Pipe G	Water Pipe H	Venturi Depth J
1	2,600/3,600	13x13	3'-8"	6'-6"	6'-5 11/16"	7'-2 3/16"	6'-7 1/2"	2'-4"	1'-3 1/2"	3"	2"	1'-5"
2	3,600/4,700	15x15	4'-1"	7'-2"	6'-8 11/16"	7'-6 11/16"	7'-2 1/2"	2'-6"	1'-5"	4"	2"	1'-5"
3	4,700/6,300	17x17	4'-8"	8'-2"	7'-2 15/16"	8'-2 15/16"	7'-11 3/4"	2'-11"	1'-7"	4"	2"	1'-9"
4	6,300/8,500	20x20	5'-3"	9'-1"	7'-8 9/16"	8'-10 9/16"	8'-10 1/2"	3'-2"	1'-9"	4"	2"	1'-9"
5	8,500/11,500	23x23	5'-11"	10'-4"	8'-9 1/4"	10'-1 3/4"	9'-10 1/2"	3'-7"	1'-11 1/2"	6"	3"	2'-4"
6	11,500/15,000	26x26	6'-7"	12'-1"	9'-6 1/2"	11'-1"	10'-11 3/4"	3'-10 3/4"	2'-1 1/2"	6"	3"	2'-4"
7	15,000/20,000	30x30	7'-5"	14'-1"	11'-3 1/4"	13'-0 3/4"	12'-5"	4'-8 1/2"	2'-4 1/2"	6"	4"	3'-1"
8	20,000/27,000	35x35	8'-4"	16'-5"	11'-10 1/2"	14'-1 1/4"	13'-7 1/2"	5'-1"	2'-9 3/4"	8"	4"	3'-1"
9	27,000/36,000	40x40	9'-4"	19'-0"	14'-6 1/2"	16'-10 1/2"	15'-7 3/4"	6'-1"	2'-11"	8"	4"	4'-4 1/2"
10	36,000/48,000	46x46	10'-6"	22'-1"	15'-4"	18'-0 1/4"	17'-2 3/8"	6'-6"	3'-3 1/4"	10"	6"	4'-4 1/2"
11	48,000/60,000	52x52	11'-10"	25'-7"	17'-6"	20'-7"	19'-3 3/8"	7'-5"	3'-8"	10"	6"	5'-10"

Sly Venturi Scrubber Efficiencies

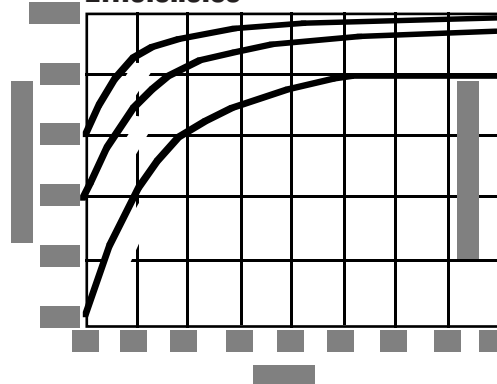

Sly Venturi Scrubber Efficiencies

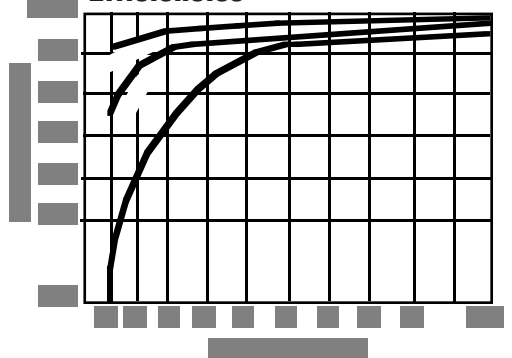

P.O. Box 5939
 Cleveland, OH 44101
 Telephone: (440) 891-3200
 Fax: (440) 891-3210
 (800) 334-2957
 www.slyinc.com
 E-mail: info@slyinc.com